

ita

INSTRUCCIONES DE FUNCIONAMIENTO





Regulación
cabezal en
altura



Regulación
del ángulo del
cabezal



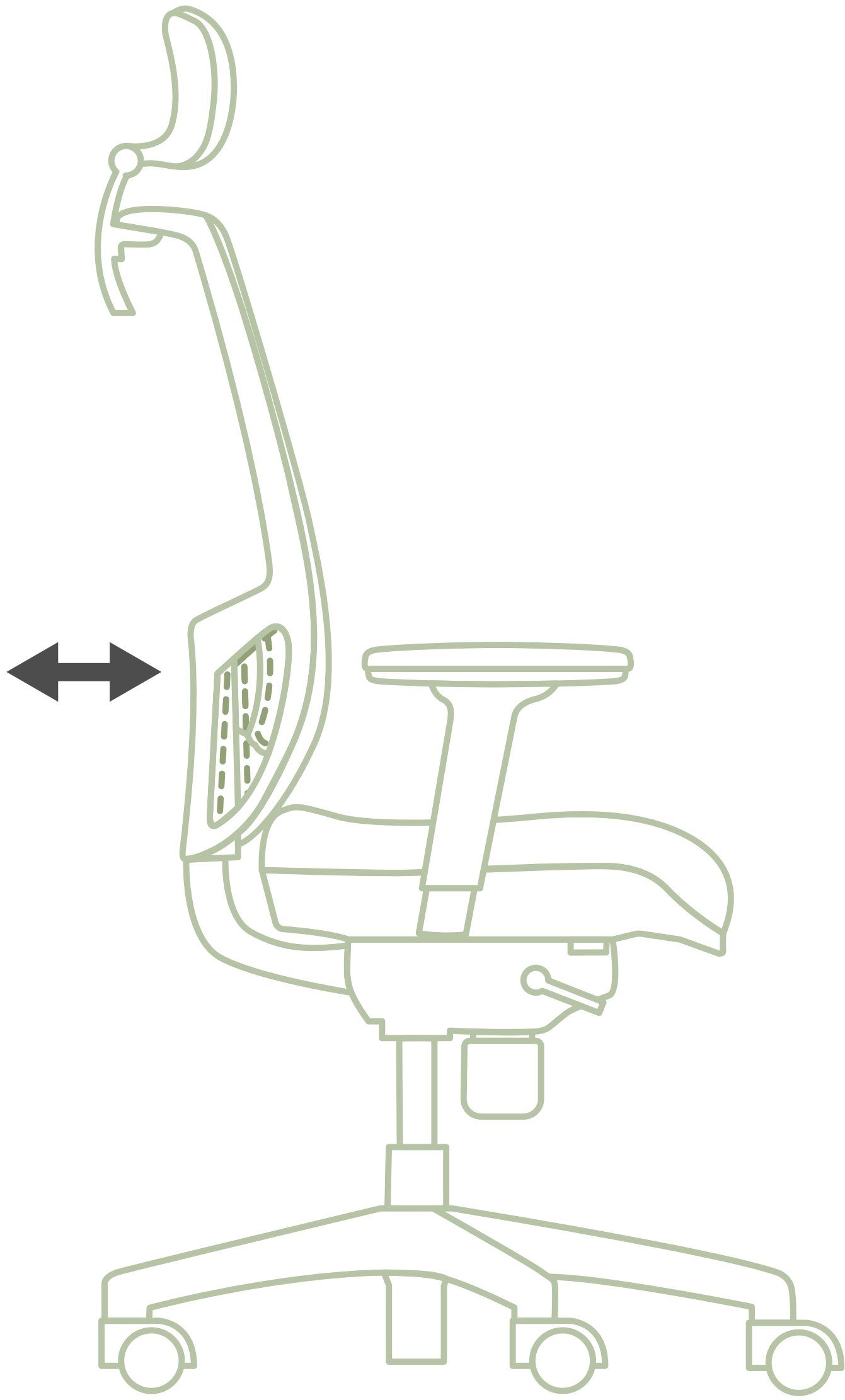

Regulación
lumbar

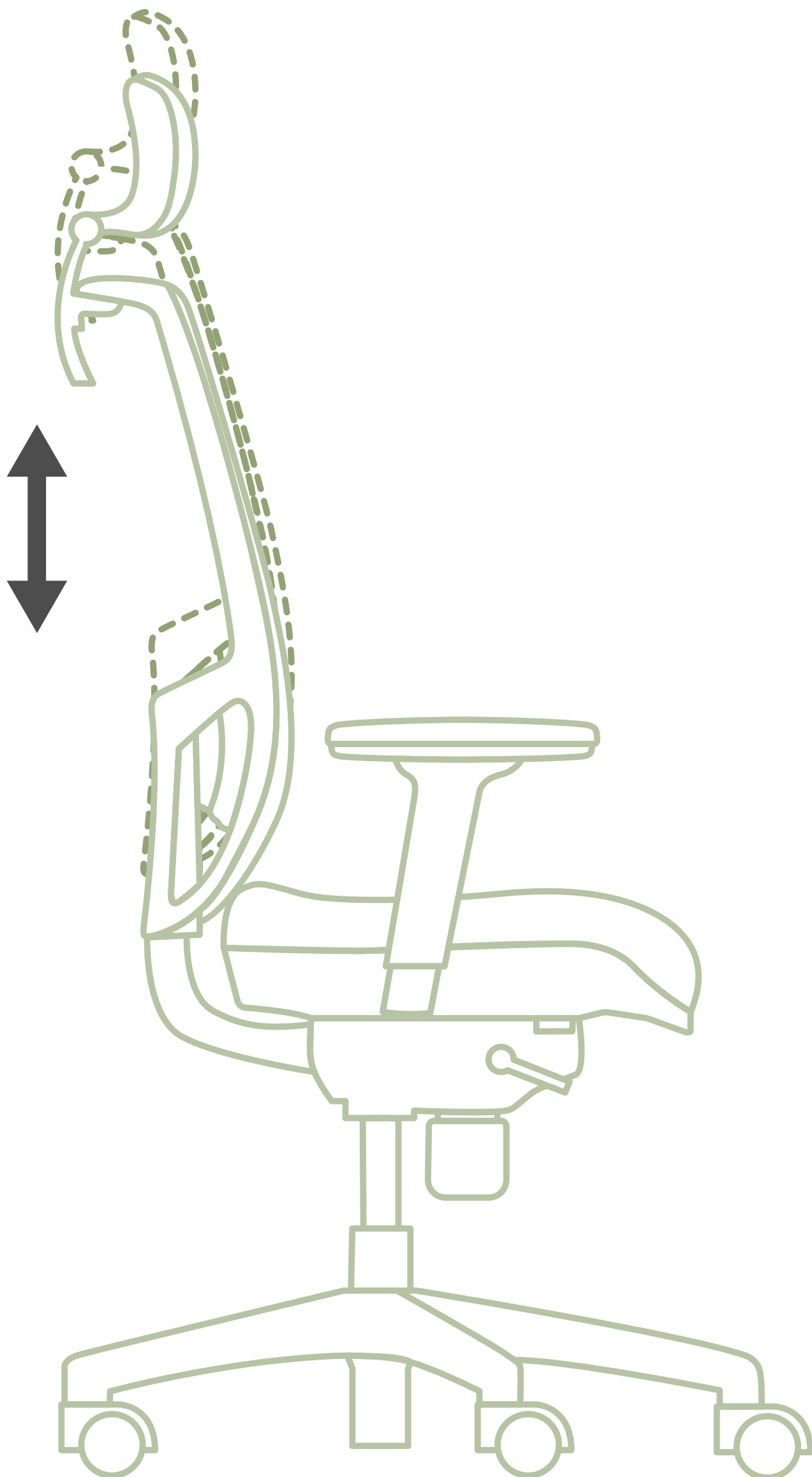

Regulación
de altura
del respaldo



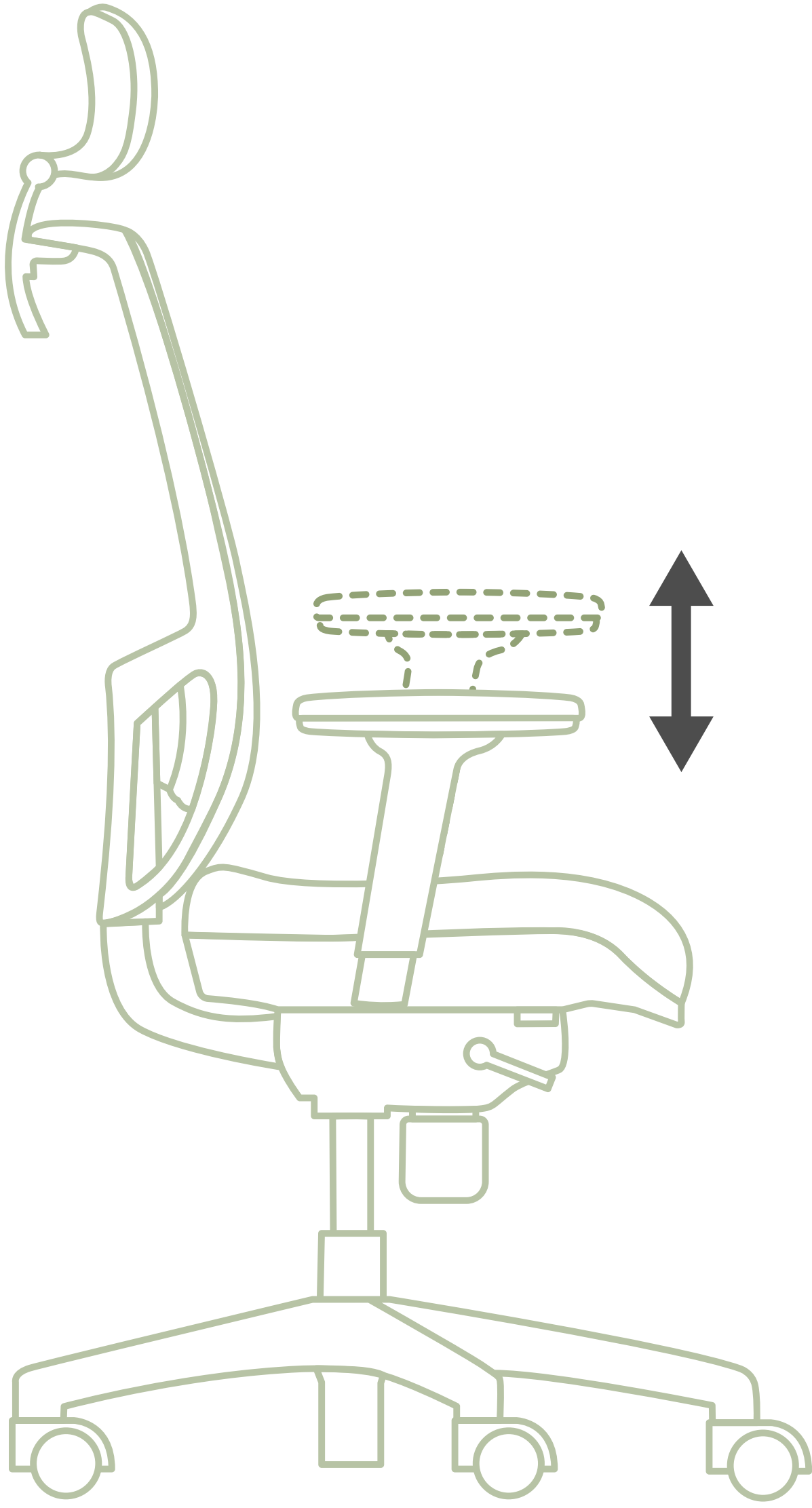

Regulación
brazos en
altura

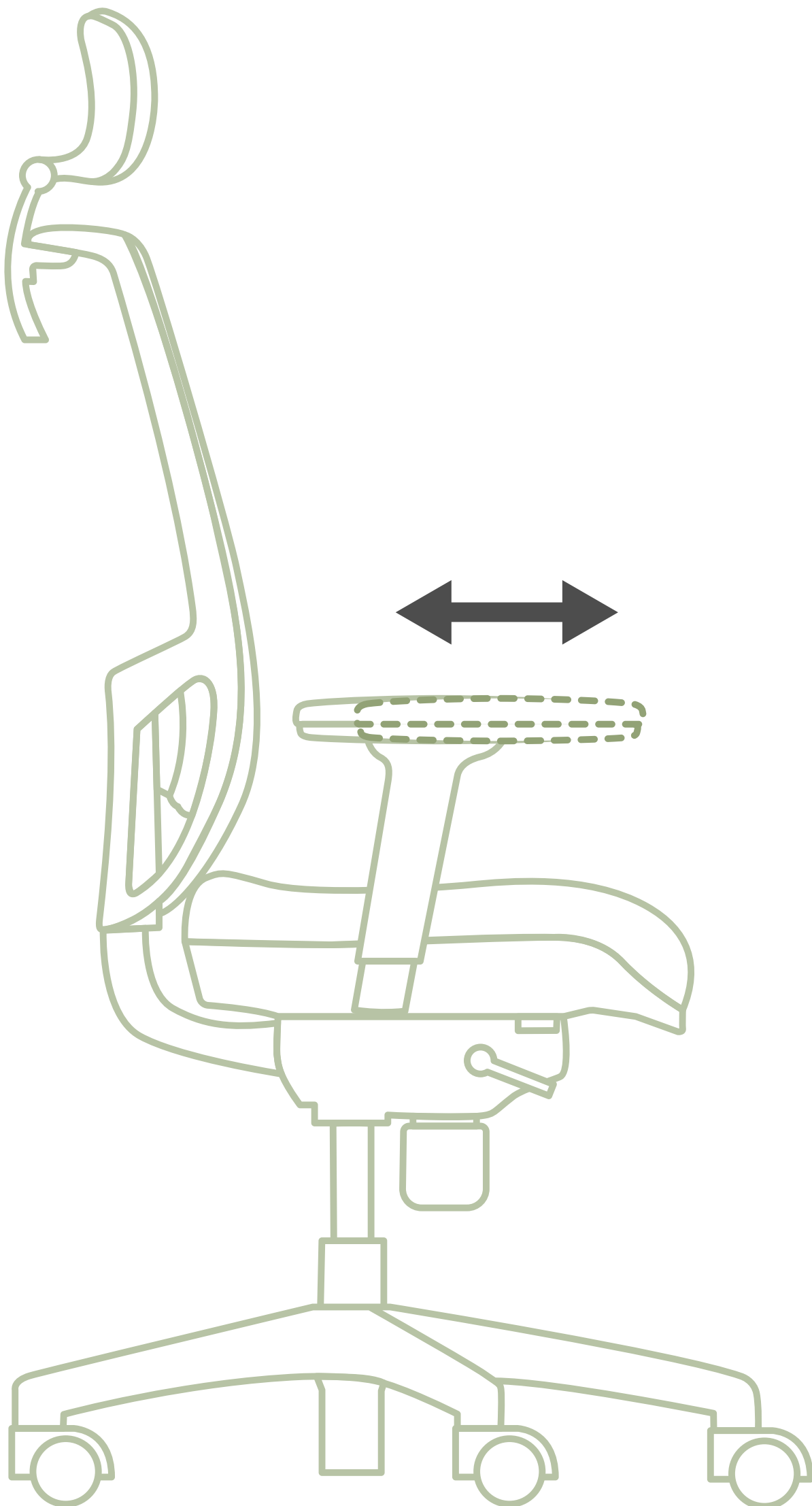

Regulación
brazos en
profundidad



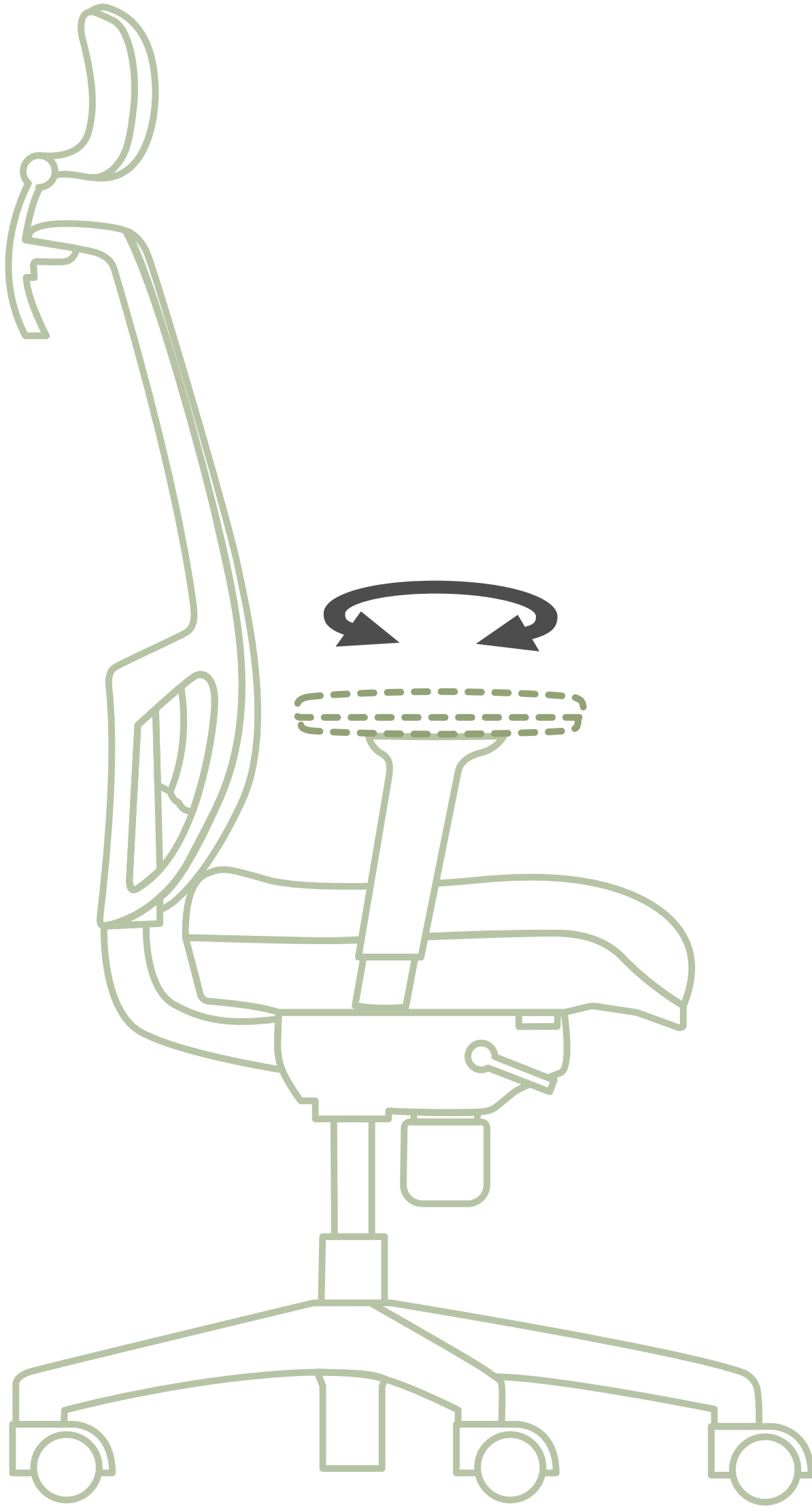

Regulación
brazos en
ángulo

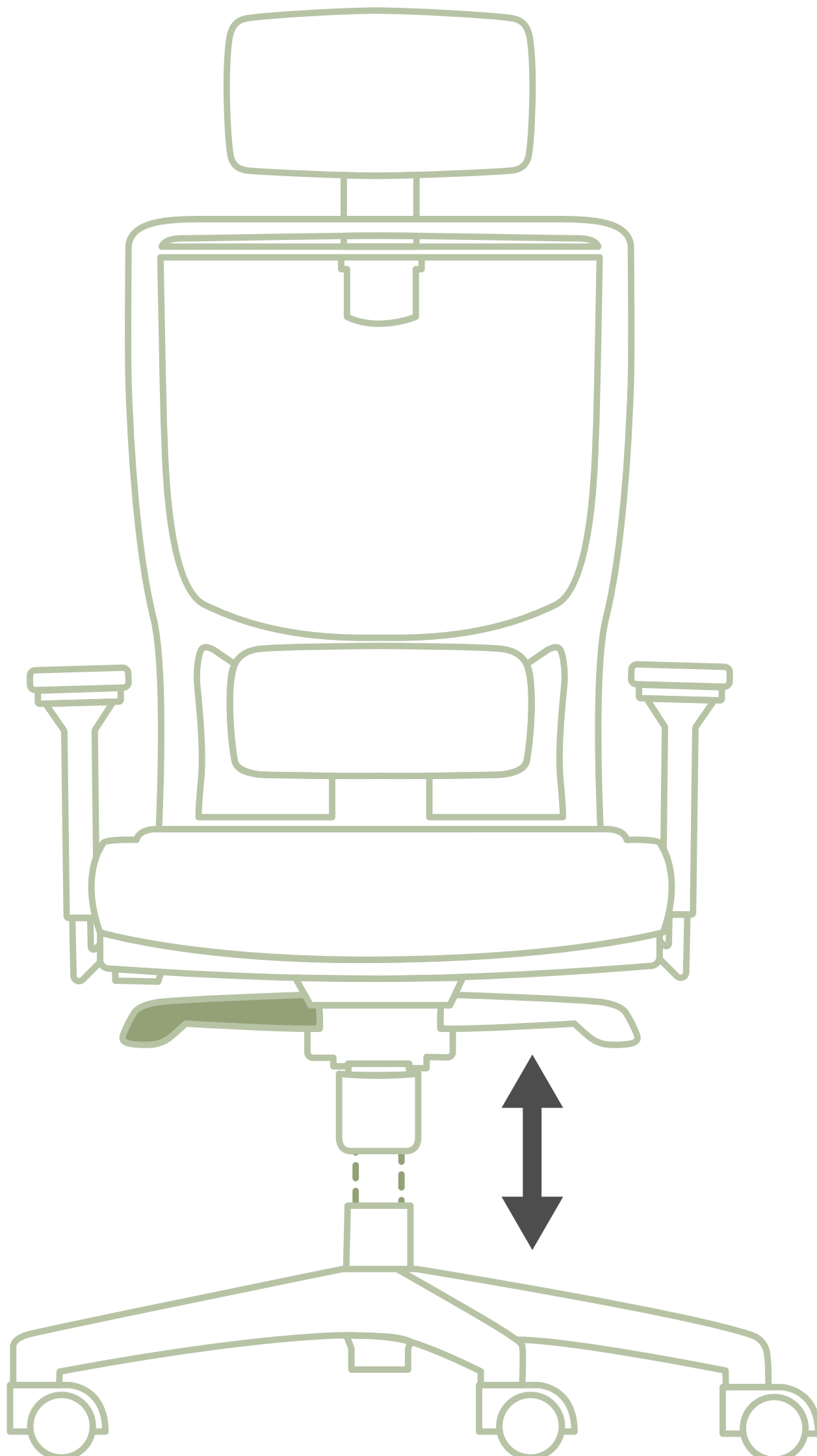

Regulación
de altura del
asiento



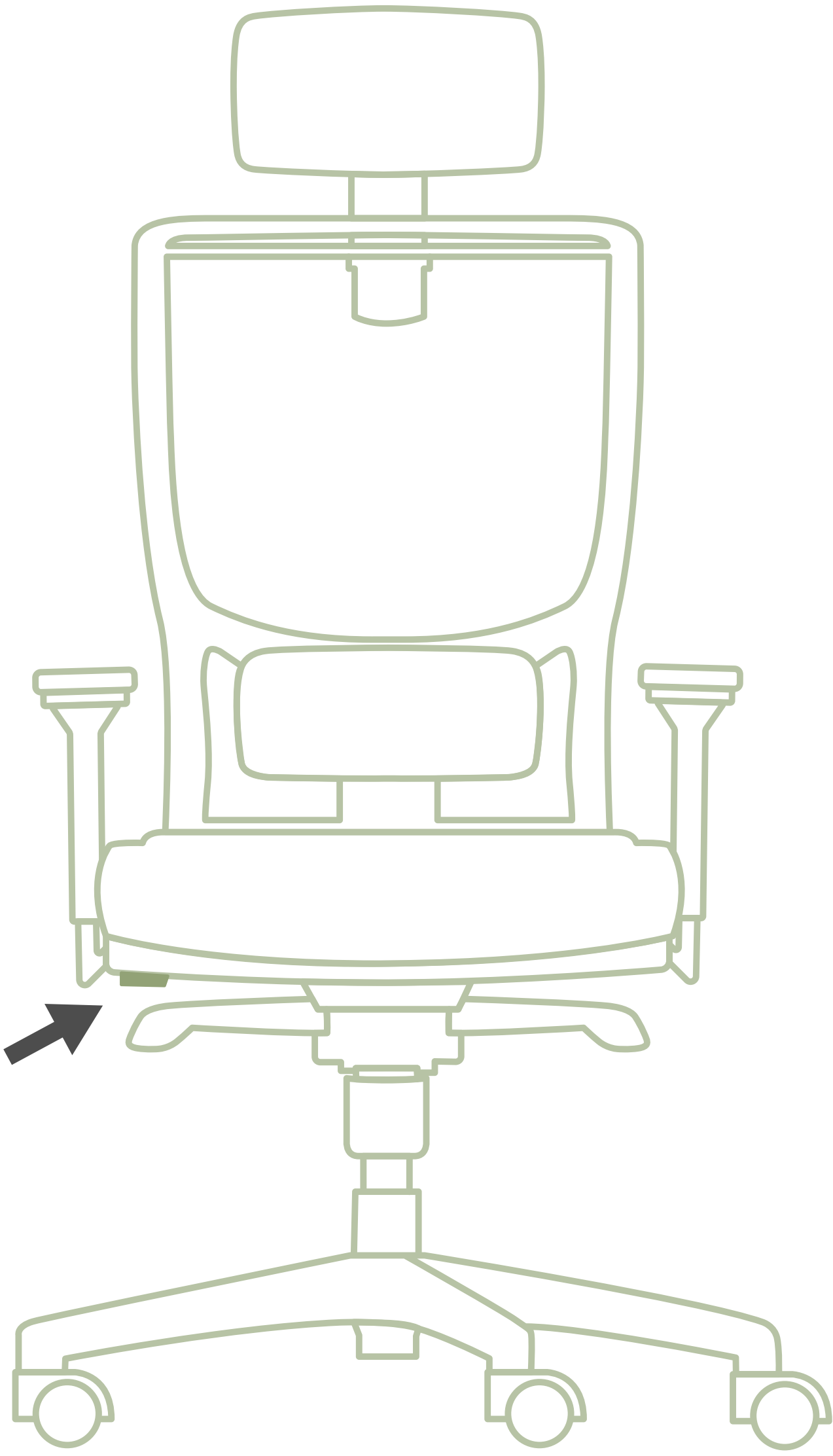

Asiento regulable en profundidad

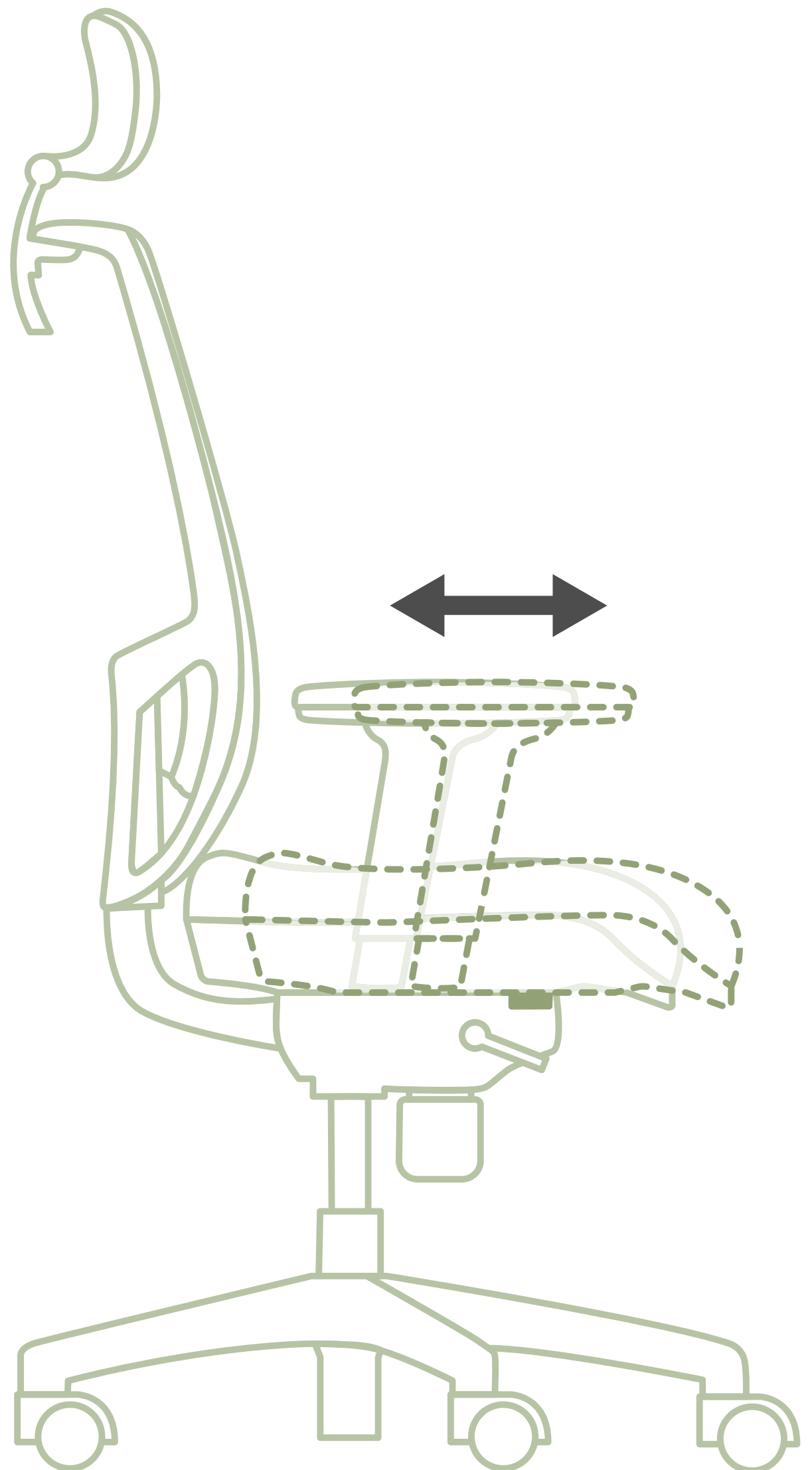

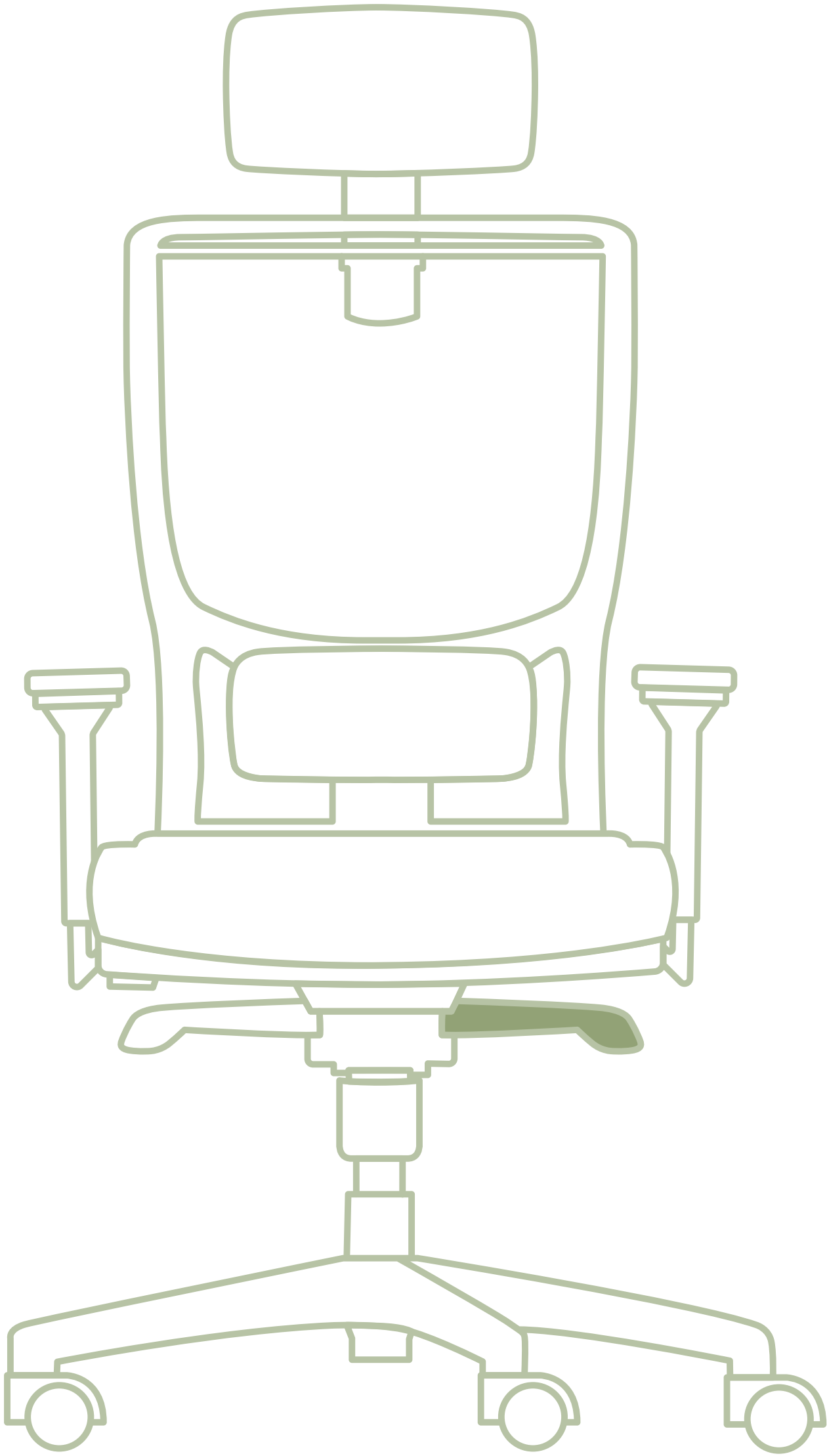

Mecanismo
Syncro con
bloqueo en **5**
posiciones

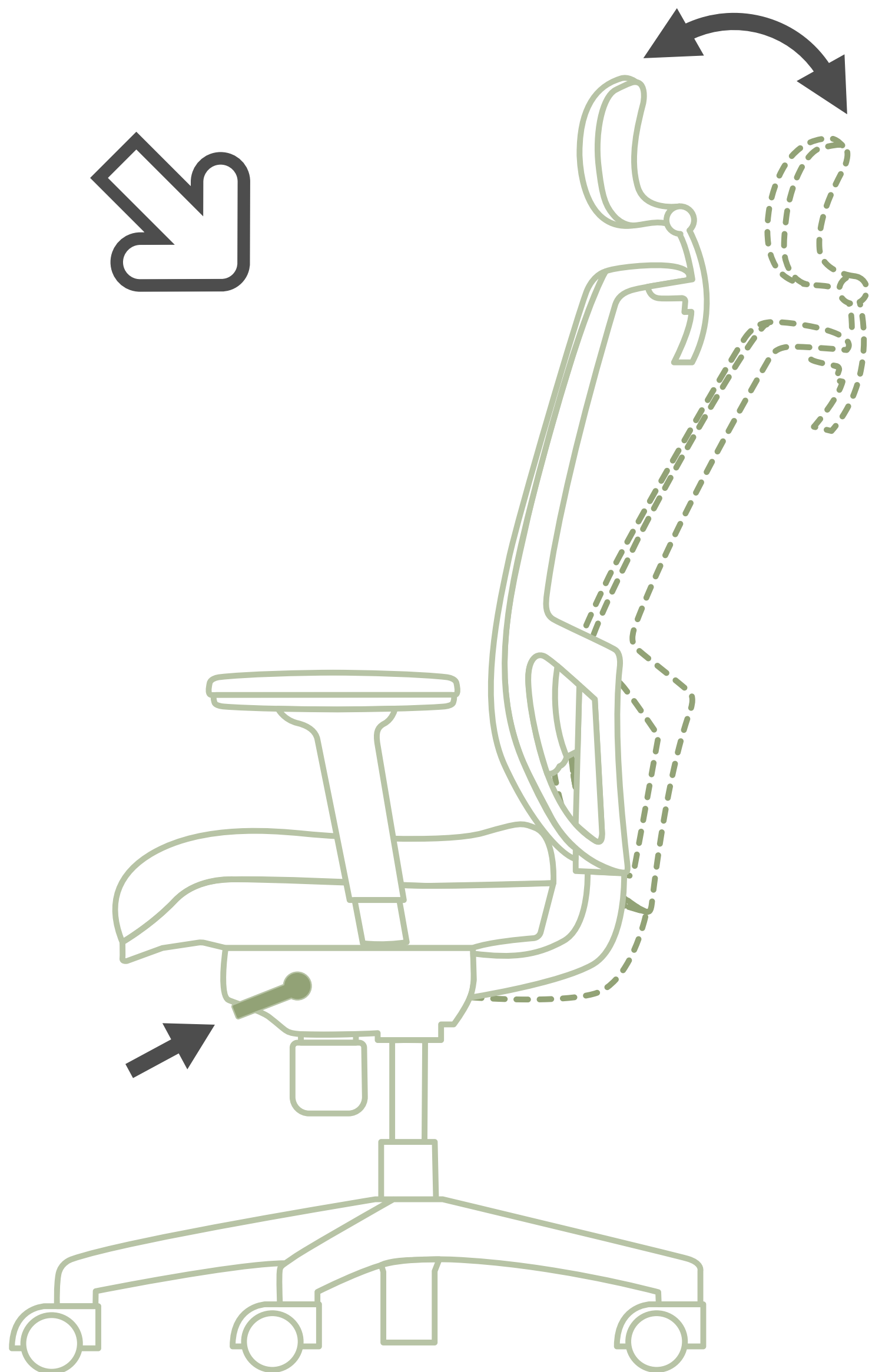
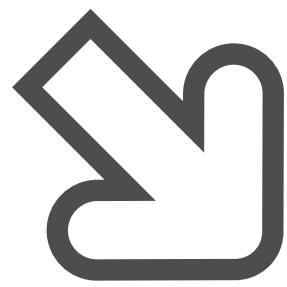



Regulación
tensión
respaldo

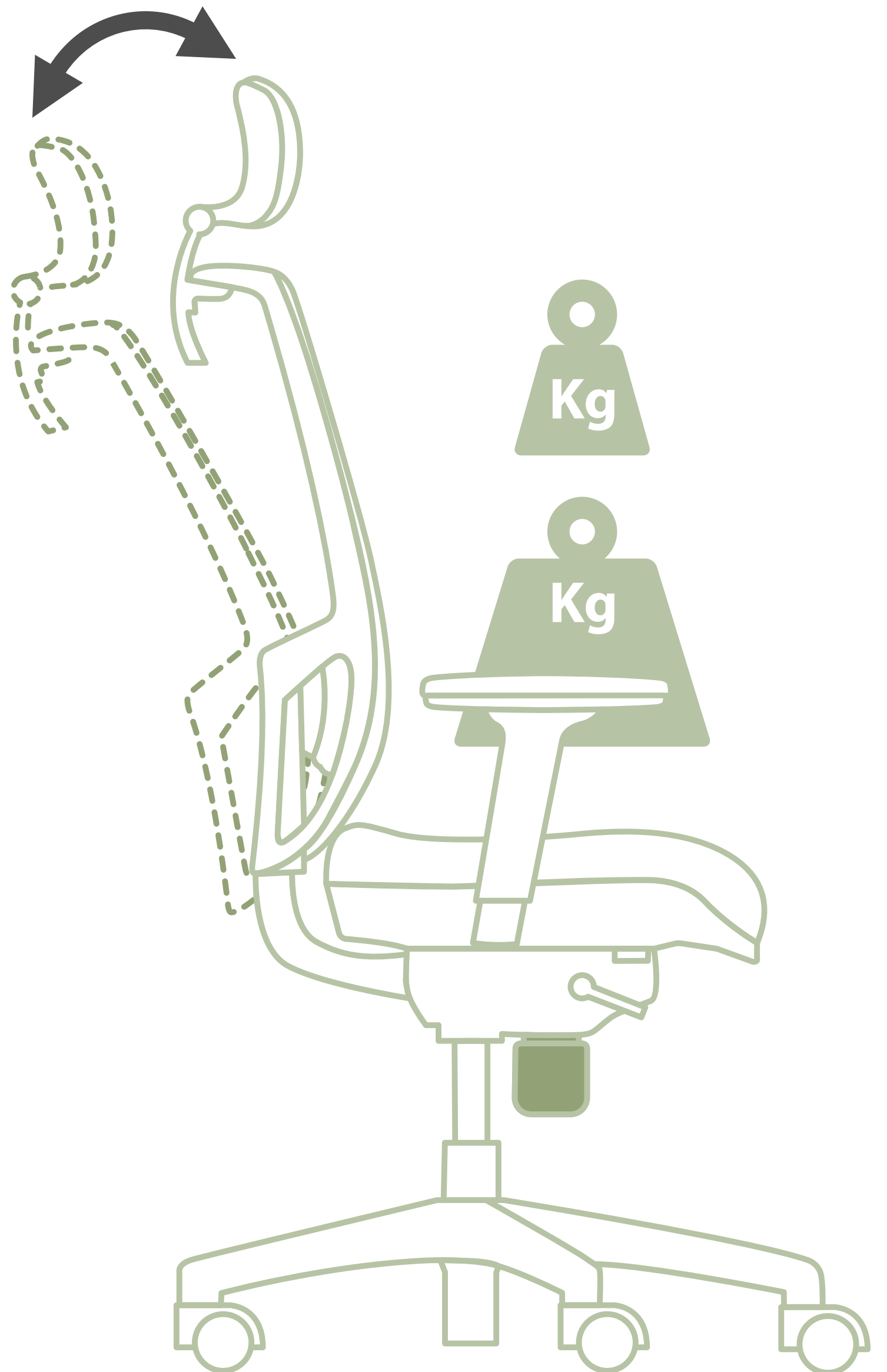
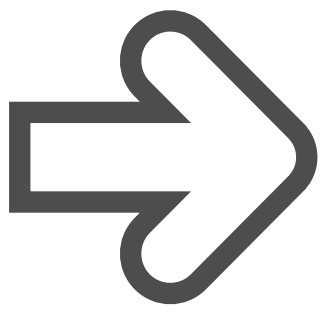



MANTENIMIENTO

Limpiar el tapizado con espuma seca y el resto con un paño húmedo.

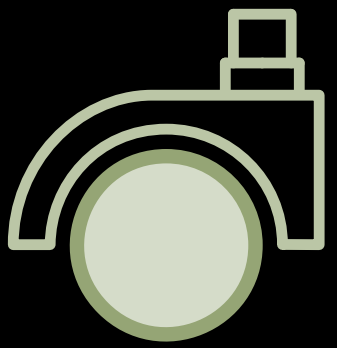

RUEDAS

Para superficies de gres, baldosas o moqueta.

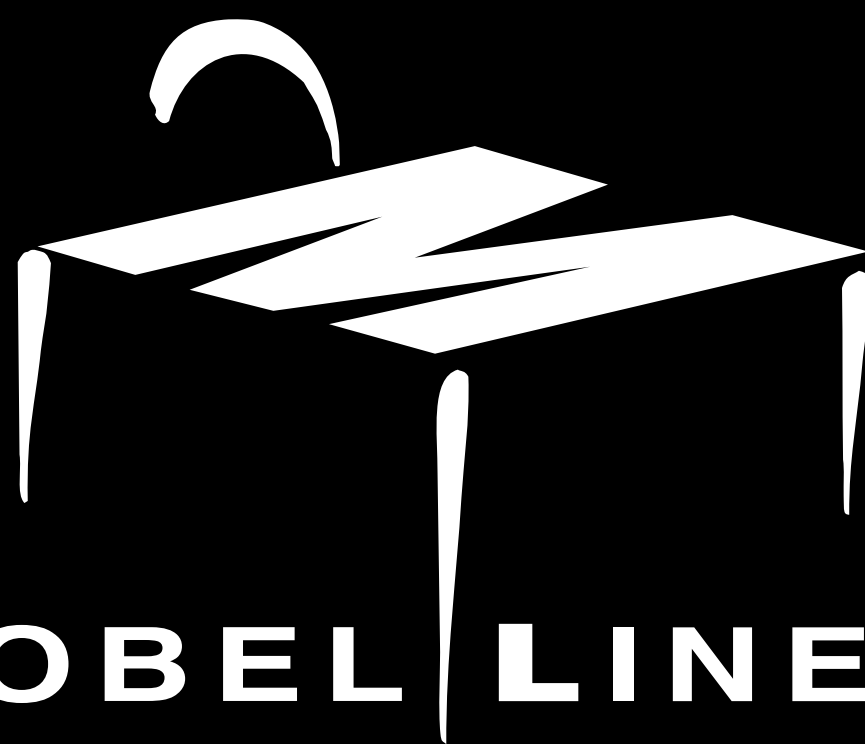

MOBEL | LINEA

Ctra. de Guissona, Km. 1

Tel. (+34) 973 53 00 50

Fax (+34) 973 53 06 49

25200 CERVERA (Lleida) - SPAIN

E-mail: mobel@mobellinea.es